

Technical data sheet

PSI AUDIO A125-M

All measurements in anechoic room
acoustical axis at 1 meter

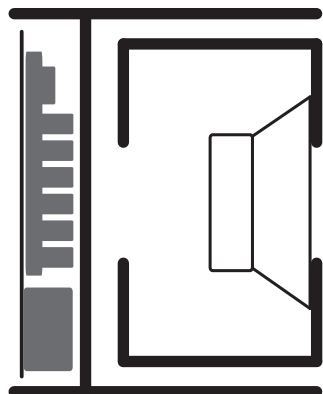

STEREO SYSTEM

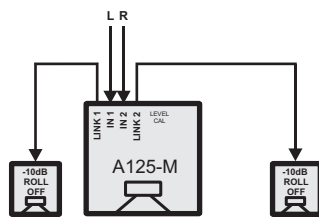

5.1 SYSTEM

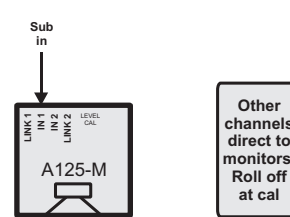

Other channels direct to monitors. Roll off at cal

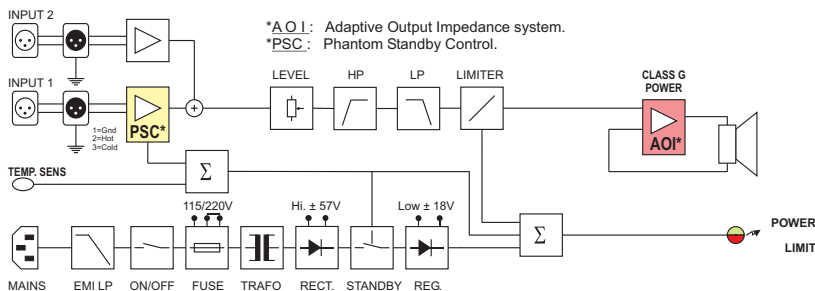

- Puissance RMS Power RMS **150 W**
- Puissance programme Program power **225 W**
- Impédance d'entrée Input Impedance **Sym, 10k Ohms**
- Sensibilité pour 100 dB @ 1m Sensivity for 100 dB @ 1m **0.775 V**
- Rapport signal sur Bruit Signal to Noise Ratio **116 dBA**
- Saturation d'entrée Input Overload **24 Vpp / 20.7 dBu**
- Niveau max. continu, 1m Continuous Max SPL, 1m **106 dB (single)**
- Niveau max. programme, 1m Program Max SPL, 1m **111 dB / half space**
- Réponse à -6 dB Response at -6dB **28 - 90 Hz**
- Tolérances Tolerances **±2 dB (31Hz - 65Hz)**
- Distorsions THD Distortion THD **< 1.5% (50Hz-200Hz)**
- Système System **1 Way(s)**
- Fréquence de coupure Crossover frequency **90Hz**
- Dim. basses Ext. / Membrane Woofer's dim. Ext. / Diaphragm **1 x Ø 258 / Ø 210 mm**
- Connecteurs Connectors **2 x XLR F / 2 x XLR M**
- Signal entrée Signal input **1=GND, 2=(+), 3=(-)**
- Matériaux du boîtier Box Material **MDF / double box**
- Dimensions boîtier L x H x P mm Dimensions cabinet W x H x D mm **320 x 480 x 385**
- Poids brut / net Gross / Net Weight **20.5 / 23.6 Kg**
- Tension de secteur Voltage **115/230V±10%(50-60Hz)**
- Consommation Consumption Standby-Quiescent-Max **1.7 - 4 - 200 W**
- Humidité Moy / Max Mean / Max Humidity **< 75% / < 90%**
- Température externe External Temperature **5 - 40 °C**

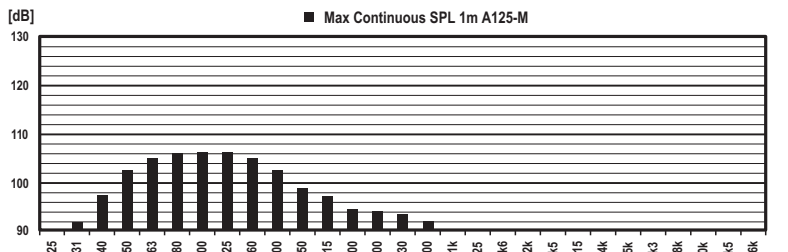
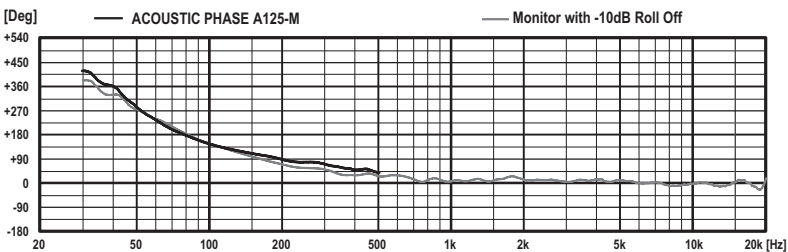
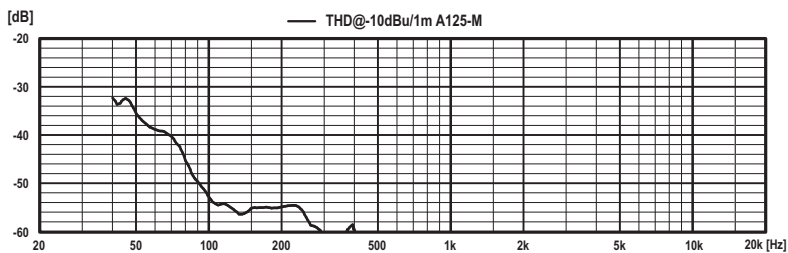
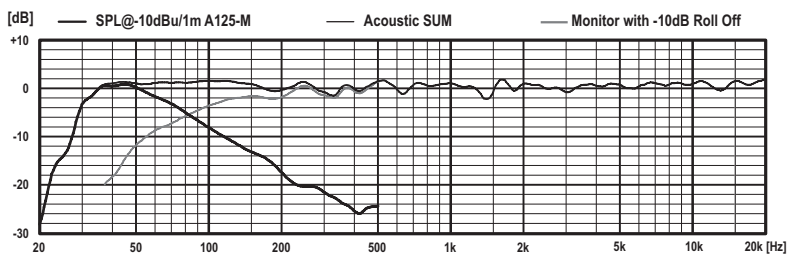

Mounting

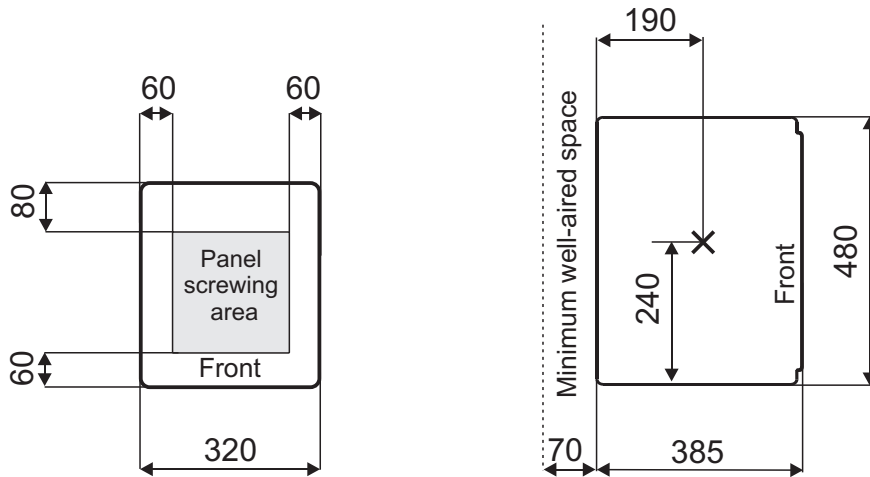

Bottom view

Side view

Refer to user manual for information about installation and safety instructions

Acoustical axis

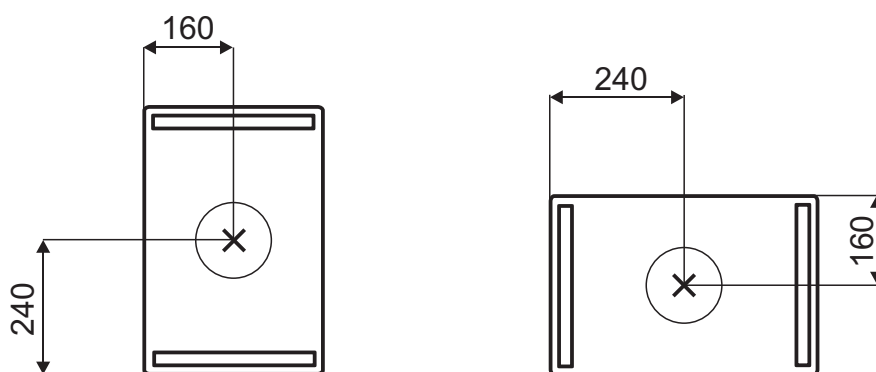

Front view

Measurement environment: Large anechoical room
 Temperature $23 \pm 2^\circ\text{C}$
 Humidity $50 \pm 20\%$